

# TMS27C010A 131 072 BY 8-BIT UV ERASABLE TMS27PC010A 131 072 BY 8-BIT PROGRAMMABLE READ-ONLY MEMORIES

SMLS110C – NOVEMBER 1990 – REVISED SEPTEMBER 1997

- Organization . . . 131 072 by 8 Bits
- Single 5-V Power Supply
- Operationally Compatible With Existing Megabit EPROMs
- Industry Standard 32-Pin Dual-In-line Package and 32-Lead Plastic Leaded Chip Carrier
- All Inputs/Outputs Fully TTL Compatible
- Maximum Access/Minimum Cycle Time  
 $V_{CC} \pm 10\%$ 

'27C/PC010A-10	100	ns
'27C/PC010A-12	120	ns
'27C/PC010A-15	150	ns
'27C/PC010A-20	200	ns
- 8-Bit Output For Use in Microprocessor-Based Systems
- Very High-Speed SNAP! Pulse Programming
- Power-Saving CMOS Technology
- 3-State Output Buffers
- 400-mV Minimum DC Noise Immunity With Standard TTL Loads
- Latchup Immunity of 250 mA on All Input and Output Pins
- No Pullup Resistors Required
- Low Power Dissipation ( $V_{CC} = 5.5\text{ V}$ )
  - Active . . . 165 mW Worst Case
  - Standby . . . 0.55 mW Worst Case (CMOS-Input Levels)
- Temperature Range Options

## description

The TMS27C010A series are 131072 by 8-bit (1048576-bit), ultraviolet (UV) light erasable, electrically programmable read-only memories (EPROMs).

The TMS27PC010A series are 131072 by 8-bit (1048576-bit), one-time programmable (OTP) electrically programmable read-only memories (PROMs).

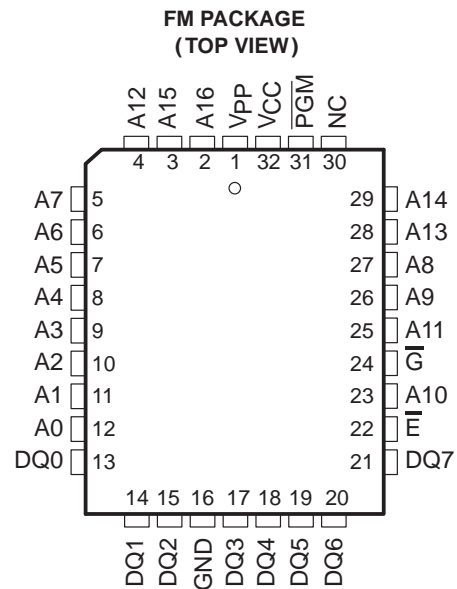
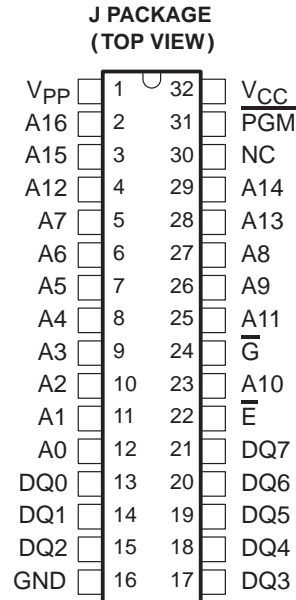

PIN NOMENCLATURE	
A0–A16	Address Inputs
DQ0–DQ7	Inputs (programming)/Outputs
E	Chip Enable
G	Output Enable
GND	Ground
NC	No Internal Connection
PGM	Program
V <sub>CC</sub>	5-V Power Supply
V <sub>PP</sub>	13-V Power Supply †

† Only in program mode



Please be aware that an important notice concerning availability, standard warranty, and use in critical applications of Texas Instruments semiconductor products and disclaimers thereto appears at the end of this data sheet.

PRODUCTION DATA information is current as of publication date. Products conform to specifications per the terms of Texas Instruments standard warranty. Production processing does not necessarily include testing of all parameters.



POST OFFICE BOX 1443 • HOUSTON, TEXAS 77251-1443

Copyright © 1997, Texas Instruments Incorporated

**TMS27C010A 131 072 BY 8-BIT UV ERASABLE**  
**TMS27PC010A 131 072 BY 8-BIT**  
**PROGRAMMABLE READ-ONLY MEMORIES**

SMLS110C – NOVEMBER 1990 – REVISED SEPTEMBER 1997

**description (continued)**

These devices are fabricated using power-saving CMOS technology for high speed and simple interface with MOS and bipolar circuits. All inputs (including program data inputs) can be driven by Series 74 TTL circuits without the use of external pullup resistors. Each output can drive one Series 74 TTL circuit without external resistors.

The TMS27C010A EPROM is offered in a dual-in-line ceramic package (J suffix) designed for insertion in mounting hole rows on 15,2-mm (600-mil) centers. The TMS27C010A is also offered with two choices of temperature ranges, 0°C to 70°C (JL suffix) and –40°C to 85°C (JE suffix). See Table 1.

The TMS27PC010A OTP PROM is offered in a 32-pin, plastic leaded chip carrier package using 1,25-mm (50-mil) lead spacing (FM suffix). The TMS27PC010A is offered with two choices of temperature ranges, 0°C to 70°C (FML suffix) and –40°C to 85°C (FME suffix). See Table 1.

**Table 1. Temperature Range Suffixes**

EPROM AND OTP PROM	SUFFIX FOR OPERATING FREE-AIR TEMPERATURE RANGES	
	0°C to 70°C	–40°C to 85°C
TMS27C010A-xxx	JL	JE
TMS27PC010A-xxx	FML	FME

These EPROMs and OTP PROMs operate from a single 5-V supply (in the read mode), thus are ideal for use in microprocessor-based systems. One other 13-V supply is needed for programming. All programming signals are TTL level. These devices are programmable using the SNAP! Pulse programming algorithm. The SNAP! Pulse programming algorithm uses a  $V_{PP}$  of 13 V and a  $V_{CC}$  of 6.5 V for a nominal programming time of thirteen seconds. For programming outside the system, existing EPROM programmers can be used. Locations can be programmed singly, in blocks, or at random.

**operation**

The seven modes of operation are listed in Table 2. The read mode requires a single 5-V supply. All inputs are TTL level except for  $V_{PP}$  during programming (13 V for SNAP! Pulse), and 12 V on A9 for signature mode.

**Table 2. Operation Modes**

FUNCTION	MODE†							
	READ	OUTPUT DISABLE	STANDBY	PROGRAMMING	VERIFY	PROGRAM INHIBIT	SIGNATURE MODE	
$\bar{E}$	$V_{IL}$	$V_{IL}$	$V_{IH}$	$V_{IL}$	$V_{IL}$	$V_{IH}$	$V_{IL}$	
$\bar{G}$	$V_{IL}$	$V_{IH}$	X	$V_{IH}$	$V_{IL}$	X	$V_{IL}$	
$\overline{PGM}$	X	X	X	$V_{IL}$	$V_{IH}$	X	X	
$V_{PP}$	$V_{CC}$	$V_{CC}$	$V_{CC}$	$V_{PP}$	$V_{PP}$	$V_{PP}$	$V_{CC}$	
$V_{CC}$	$V_{CC}$	$V_{CC}$	$V_{CC}$	$V_{CC}$	$V_{CC}$	$V_{CC}$	$V_{CC}$	
A9	X	X	X	X	X	X	$V_{H}‡$ $V_{H}‡$	
A0	X	X	X	X	X	X	$V_{IL}$ $V_{IH}$	
DQ0–DQ7	Data Out	Hi-Z	Hi-Z	Data In	Data Out	Hi-Z	CODE	
							MFG	DEVICE
							97	D6

† X can be  $V_{IL}$  or  $V_{IH}$ .

‡  $V_{H} = 12 V \pm 0.5 V$ .



### **read/output disable**

When the outputs of two or more TMS27C010As or TMS27PC010As are connected in parallel on the same bus, the output of any particular device in the circuit can be read with no interference from competing outputs of the other devices. To read the output of a single device, a low-level signal is applied to the  $\overline{E}$  and  $\overline{G}$  pins. All other devices in the circuit should have their outputs disabled by applying a high level signal to one of these pins.

### **latchup immunity**

Latchup immunity on the TMS27C010A and TMS27PC010A is a minimum of 250 mA on all inputs and outputs. This feature provides latchup immunity beyond any potential transients at the P.C. board level when the devices are interfaced to industry standard TTL or MOS logic devices. The input/output layout approach controls latchup without compromising performance or packing density.

### **power down**

Active  $I_{CC}$  supply current can be reduced from 30 mA to 500  $\mu$ A by applying a high TTL input on  $\overline{E}$  and to 100  $\mu$ A by applying a high CMOS input on  $\overline{E}$ . In this mode all outputs are in the high-impedance state.

### **erasure (TMS27C010A)**

Before programming, the TMS27C010A EPROM is erased by exposing the chip through the transparent lid to a high intensity UV light (wavelength 2537 Å). The recommended minimum exposure dose (UV intensity  $\times$  exposure time) is 15-W·s/cm<sup>2</sup>. A typical 12-mW/cm<sup>2</sup>, filterless UV lamp erases the device in 21 minutes. The lamp should be located about 2.5 cm above the chip during erasure. After erasure, all bits are in the high state. Normal ambient light contains the correct wavelength for erasure, therefore, when using the TMS27C010A, the window must be covered with an opaque label. After erasure (all bits in logic high state), logic lows are programmed into the desired locations. A programmed low can be erased only by UV light.

### **initializing (TMS27PC010A)**

The one-time programmable TMS27PC010A PROM is provided with all bits in the logic high state, then logic lows are programmed into the desired locations. Logic lows programmed into an OTP PROM cannot be erased.

### **SNAP! Pulse programming**

The TMS27C010A and TMS27PC010A are programmed using the TI SNAP! Pulse programming algorithm illustrated by the flowchart in Figure 1, which programs in a nominal time of thirteen seconds. Actual programming time varies as a function of the programmer used.

The SNAP! Pulse programming algorithm uses an initial pulse of 100 microseconds ( $\mu$ s) followed by a byte verification to determine when the addressed byte has been successfully programmed. Up to 10 (ten) 100- $\mu$ s pulses per byte are provided before a failure is recognized.

The programming mode is achieved when  $V_{PP} = 13$  V,  $V_{CC} = 6.5$  V,  $\overline{E} = V_{IL}$ ,  $\overline{G} = V_{IH}$ . Data is presented in parallel (eight bits) on pins DQ0 through DQ7. Once addresses and data are stable,  $\overline{PGM}$  is pulsed low.

More than one device can be programmed when the devices are connected in parallel. Locations can be programmed in any order. When the SNAP! Pulse programming routine is complete, all bits are verified with  $V_{CC} = V_{PP} = 5$  V  $\pm$  10%.

### **program inhibit**

Programming can be inhibited by maintaining a high level input on the  $\overline{E}$  or  $\overline{PGM}$  pins.

### **program verify**

Programmed bits can be verified with  $V_{PP} = 13$  V when  $\overline{G} = V_{IL}$ ,  $\overline{E} = V_{IL}$ , and  $\overline{PGM} = V_{IH}$ .

**TMS27C010A 131 072 BY 8-BIT UV ERASABLE  
TMS27PC010A 131 072 BY 8-BIT  
PROGRAMMABLE READ-ONLY MEMORIES**

SMLS110C – NOVEMBER 1990 – REVISED SEPTEMBER 1997

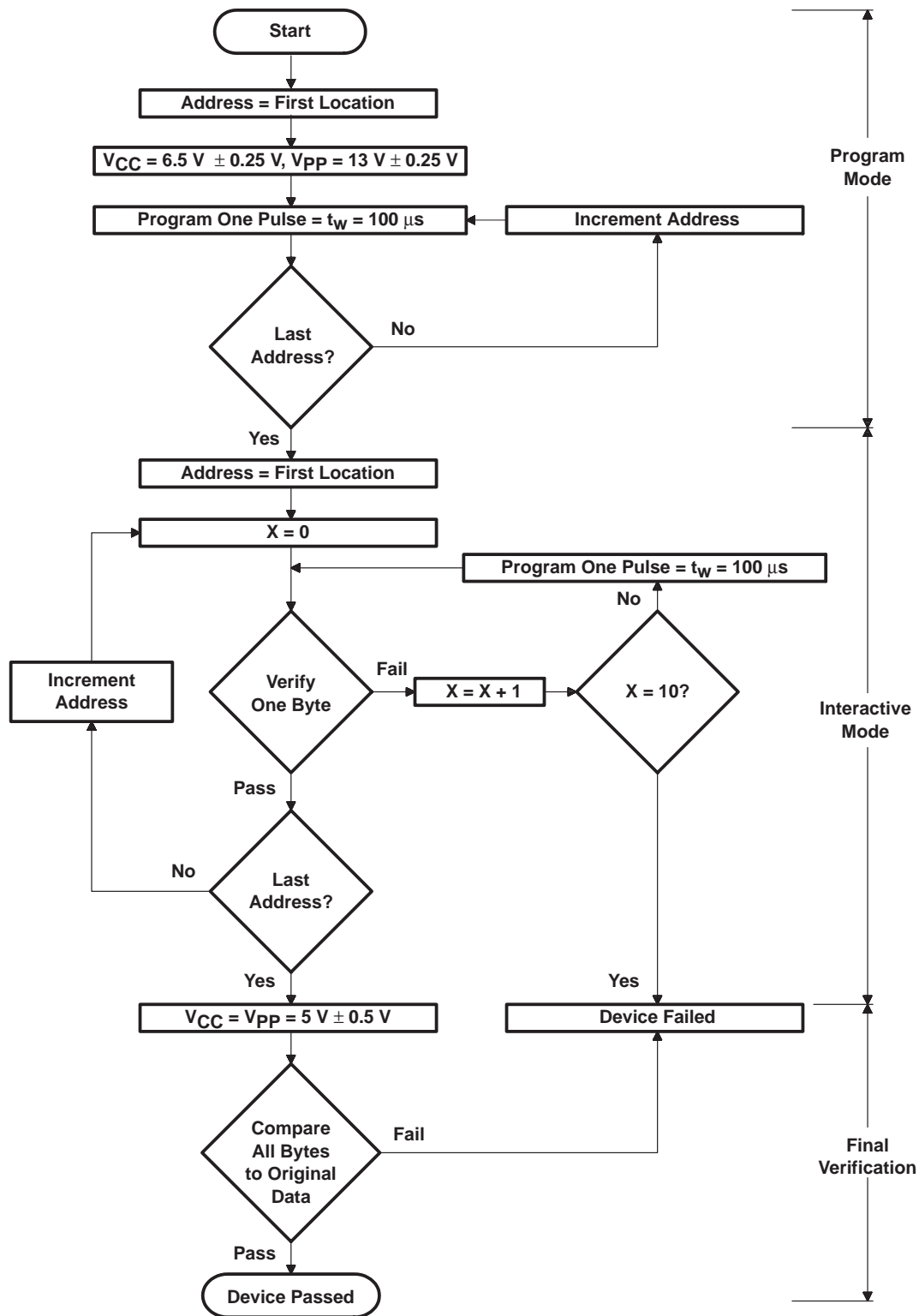

Figure 1. SNAP! Pulse Programming Flowchart



**TMS27C010A 131 072 BY 8-BIT UV ERASABLE  
TMS27PC010A 131 072 BY 8-BIT  
PROGRAMMABLE READ-ONLY MEMORIES**

SMLS110C – NOVEMBER 1990 – REVISED SEPTEMBER 1997

**signature mode**

The signature mode provides access to a binary code identifying the manufacturer and type. This mode is activated when A9 (pin 26) is forced to 12 V. Two identifier bytes are accessed by toggling A0. All other addresses must be held low. The signature code for these devices is 97D6. A0 low selects the manufacturer's code 97 (Hex), and A0 high selects the device code D6 (Hex), as shown in Table 3.

**Table 3. Signature Mode**

IDENTIFIER†	PINS									
	A0	DQ7	DQ6	DQ5	DQ4	DQ3	DQ2	DQ1	DQ0	HEX
MANUFACTURER CODE	V <sub>IL</sub>	1	0	0	1	0	1	1	1	97
DEVICE CODE	V <sub>IH</sub>	1	1	0	1	0	1	1	0	D6

†  $\bar{E} = \bar{G} = V_{IL}$ , A1–A8 = V<sub>IL</sub>, A9 = V<sub>H</sub>, A10–A16 = V<sub>IL</sub>, V<sub>PP</sub> = V<sub>CC</sub>.

**logic symbol‡**

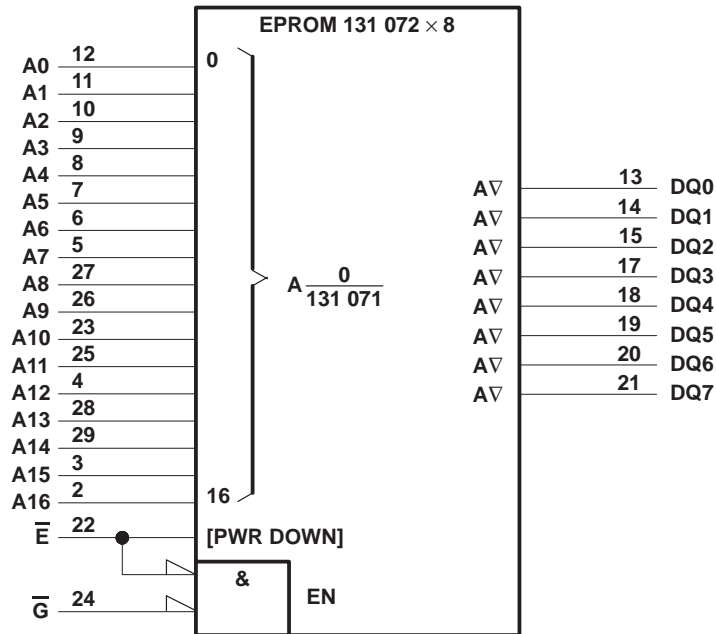

‡ This symbol is in accordance with ANSI/IEEE Std 91-1984 and IEC Publication 617-12. J package illustrated.



**TMS27C010A 131 072 BY 8-BIT UV ERASABLE  
TMS27PC010A 131 072 BY 8-BIT  
PROGRAMMABLE READ-ONLY MEMORIES**

SMLS110C – NOVEMBER 1990 – REVISED SEPTEMBER 1997

**electrical characteristics over recommended ranges of supply voltage and operating free-air temperature**

PARAMETER		TEST CONDITIONS	MIN	MAX	UNIT
V <sub>OH</sub>	High-level dc output voltage	I <sub>OH</sub> = -20 μA	V <sub>CC</sub> - 0.2		V
		I <sub>OH</sub> = -2.5 mA	3.5		
V <sub>OL</sub>	Low-level dc output voltage	I <sub>OL</sub> = 2.1 mA		0.4	V
		I <sub>OL</sub> = 20 μA		0.1	
I <sub>I</sub>	Input current (leakage)	V <sub>I</sub> = 0 V to 5.5 V		±1	μA
I <sub>O</sub>	Output current (leakage)	V <sub>O</sub> = 0 V to V <sub>CC</sub>		±1	μA
I <sub>PP1</sub>	V <sub>PP</sub> supply current	V <sub>PP</sub> = V <sub>CC</sub> = 5.5 V		10	μA
I <sub>PP2</sub>	V <sub>PP</sub> supply current (during program pulse)	V <sub>PP</sub> = 13 V		50	mA
I <sub>CC1</sub>	V <sub>CC</sub> supply current (standby)	TTL-input level	V <sub>CC</sub> = 5.5 V, $\bar{E} = V_{IH}$	500	μA
		CMOS-input level	V <sub>CC</sub> = 5.5 V, $\bar{E} = V_{CC} \pm 0.2$ V	100	
I <sub>CC2</sub>	V <sub>CC</sub> supply current (active) (output open)	V <sub>CC</sub> = 5.5 V, $\bar{E} = V_{IL}$ t <sub>cycle</sub> = minimum cycle time†, outputs open		30	mA

† Minimum cycle time = maximum access time.

**capacitance over recommended ranges of supply voltage and operating free-air temperature, f = 1 MHz‡**

PARAMETER		TEST CONDITIONS	MIN	TYP§	MAX	UNIT
C <sub>I</sub>	Input capacitance	V <sub>I</sub> = 0 V, f = 1 MHz		4	8	pF
C <sub>O</sub>	Output capacitance	V <sub>O</sub> = 0 V, f = 1 MHz		6	10	pF

‡ Capacitance measurements are made on sample basis only.

§ All typical values are at T<sub>A</sub> = 25°C and nominal voltages.

**switching characteristics over recommended ranges of operating conditions (see Notes 4 and 5)**

PARAMETER	TEST CONDITIONS	'27C010A-10		'27C010A-12		'27C010A-15		'27C010A-20		UNIT
		MIN	MAX	MIN	MAX	MIN	MAX	MIN	MAX	
t <sub>a(A)</sub>	Access time from address		100		120		150		200	ns
t <sub>a(E)</sub>	Access time from chip enable		100		120		150		200	ns
t <sub>en(G)</sub>	Output enable time from $\bar{G}$		55		55		75		75	ns
t <sub>dis</sub>	Output disable time from $\bar{G}$ or $\bar{E}$ , whichever occurs first¶	0	50	0	50	0	60	0	60	ns
t <sub>v(A)</sub>	Output data valid time after change of address, $\bar{E}$ , or $\bar{G}$ , whichever occurs first¶	0		0		0		0		ns

¶ Value calculated from 0.5-V delta to measured output level.

NOTES: 4. For all switching characteristics the input pulse levels are 0.4 V to 2.4 V. Timing measurements are made at 2 V for logic high and 0.8 V for logic low (see Figure 2).

5. Common test conditions apply for t<sub>dis</sub> except during programming.



**TMS27C010A 131 072 BY 8-BIT UV ERASABLE  
TMS27PC010A 131 072 BY 8-BIT  
PROGRAMMABLE READ-ONLY MEMORIES**

SMLS110C – NOVEMBER 1990 – REVISED SEPTEMBER 1997

**switching characteristics for programming:  $V_{CC} = 6.5\text{ V}$  and  $V_{PP} = 13\text{ V}$  (SNAP! Pulse),  $T_A = 25^\circ\text{C}$  (see Note 4)**

PARAMETER		MIN	MAX	UNIT
$t_{dis}(G)$	Disable time, output disable time from $\overline{G}$	0	130	ns
$t_{en}(G)$	Enable time, output enable time from $\overline{G}$		150	ns

NOTE 4: For all switching characteristics the input pulse levels are 0.4 V to 2.4 V. Timing measurements are made at 2 V for logic high and 0.8 V for logic low (see the ac testing waveform).

**timing requirements for programming**

		MIN	NOM	MAX	UNIT		
$t_w(\text{PGM})$	Pulse duration, program	SNAP! Pulse programming algorithm		95	100	105	$\mu\text{s}$
$t_{su}(A)$	Setup time, address			2			$\mu\text{s}$
$t_{su}(E)$	Setup time, $\overline{E}$			2			$\mu\text{s}$
$t_{su}(G)$	Setup time, $\overline{G}$			2			$\mu\text{s}$
$t_{su}(D)$	Setup time, data			2			$\mu\text{s}$
$t_{su}(V_{PP})$	Setup time, $V_{PP}$			2			$\mu\text{s}$
$t_{su}(V_{CC})$	Setup time, $V_{CC}$			2			$\mu\text{s}$
$t_h(A)$	Hold time, address			0			$\mu\text{s}$
$t_h(D)$	Hold time, data			2			$\mu\text{s}$





PARAMETER MEASUREMENT INFORMATION

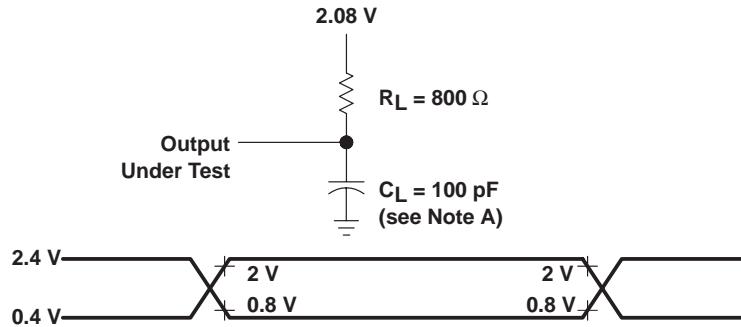

- NOTES: A.  $C_L$  includes probe and fixture capacitance.  
B. The ac testing inputs are driven at 2.4 V for logic high and 0.4 V for logic low. Timing measurements are made at 2 V for logic high and 0.8 V for logic low for both inputs and outputs.

Figure 2. The ac Test Output Load Circuit and Waveform

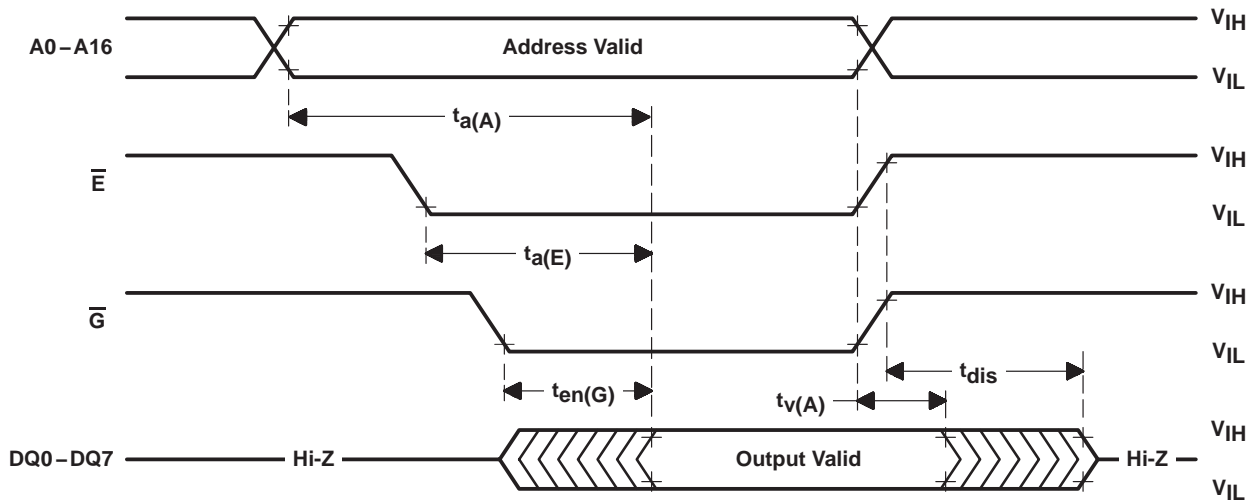
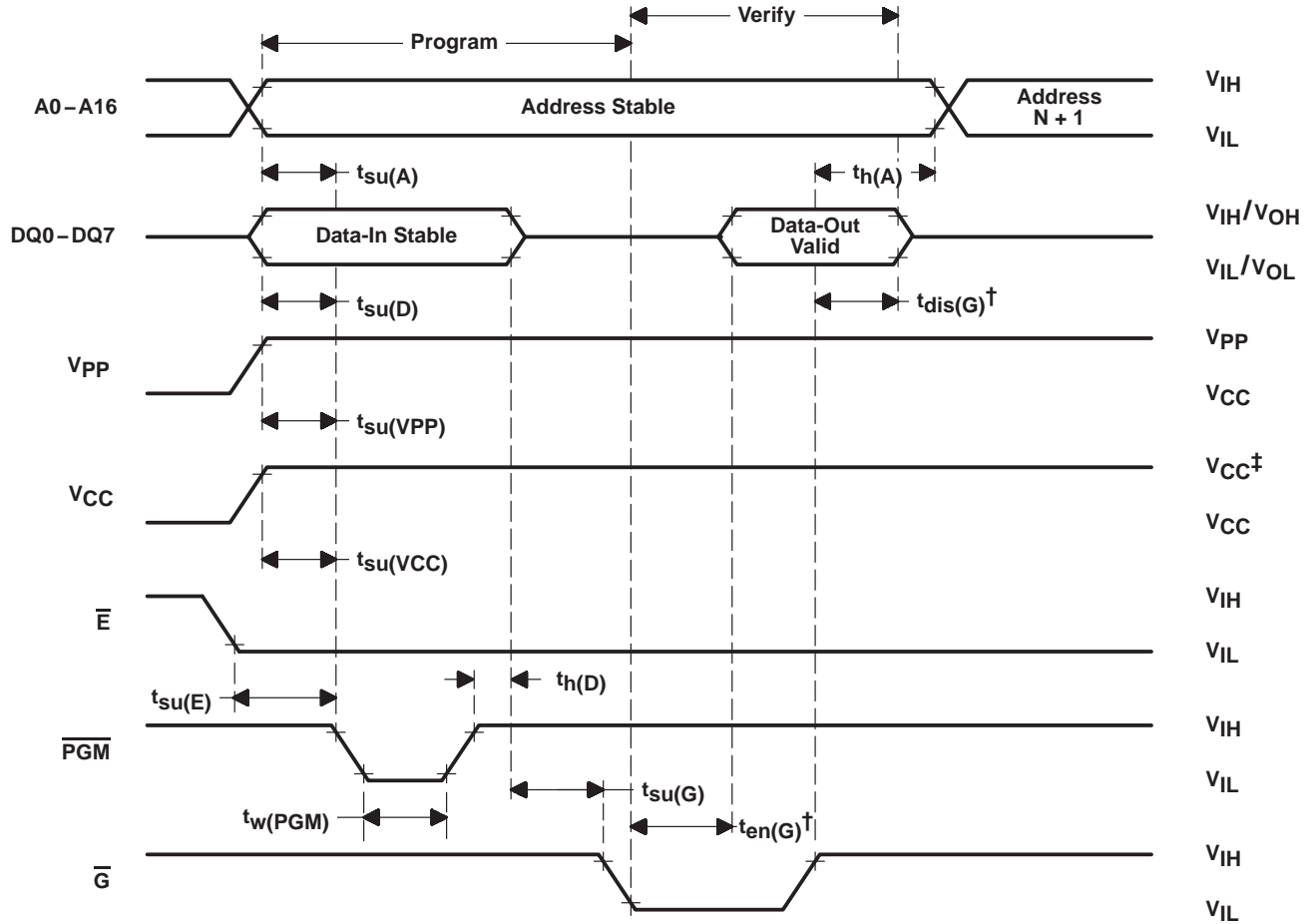

Figure 3. Read-Cycle Timing

**TMS27C010A 131 072 BY 8-BIT UV ERASABLE  
TMS27PC010A 131 072 BY 8-BIT  
PROGRAMMABLE READ-ONLY MEMORIES**

SMLS110C – NOVEMBER 1990 – REVISED SEPTEMBER 1997

**PROGRAMMING INFORMATION**



† t<sub>dis</sub>(G) and t<sub>en</sub>(G) are characteristics of the device but must be accommodated by the programmer.

‡ 13-V V<sub>PP</sub> and 6.5-V V<sub>CC</sub> for SNAP! Pulse programming.

**Figure 4. Program-Cycle Timing (SNAP! Pulse Programming)**



**TMS27C010A 131 072 BY 8-BIT UV ERASABLE  
TMS27PC010A 131 072 BY 8-BIT  
PROGRAMMABLE READ-ONLY MEMORIES**

SMLS110C – NOVEMBER 1990 – REVISED SEPTEMBER 1997

**J (R-CDIP-T\*\*)**

**CERAMIC SIDE-BRAZE DUAL-IN-LINE PACKAGE**

24 PIN SHOWN

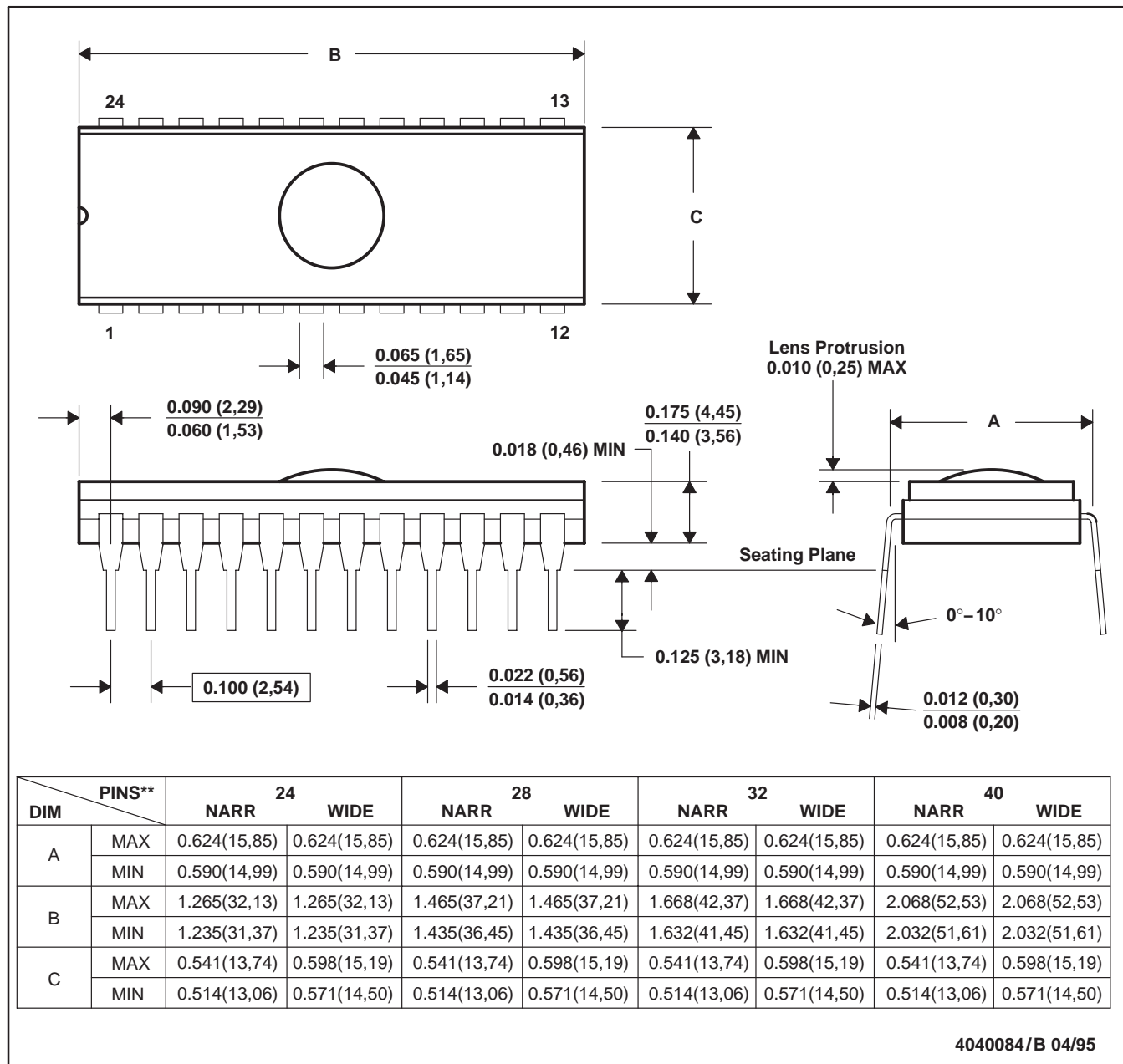

- NOTES: A. All linear dimensions are in inches (millimeters).  
 B. This drawing is subject to change without notice.  
 C. This package can be hermetically sealed with a ceramic lid using glass frit.  
 D. Index point is provided on cap for terminal identification only on press ceramic glass frit seal only.

## IMPORTANT NOTICE

Texas Instruments Incorporated and its subsidiaries (TI) reserve the right to make corrections, modifications, enhancements, improvements, and other changes to its products and services at any time and to discontinue any product or service without notice. Customers should obtain the latest relevant information before placing orders and should verify that such information is current and complete. All products are sold subject to TI's terms and conditions of sale supplied at the time of order acknowledgment.

TI warrants performance of its hardware products to the specifications applicable at the time of sale in accordance with TI's standard warranty. Testing and other quality control techniques are used to the extent TI deems necessary to support this warranty. Except where mandated by government requirements, testing of all parameters of each product is not necessarily performed.

TI assumes no liability for applications assistance or customer product design. Customers are responsible for their products and applications using TI components. To minimize the risks associated with customer products and applications, customers should provide adequate design and operating safeguards.

TI does not warrant or represent that any license, either express or implied, is granted under any TI patent right, copyright, mask work right, or other TI intellectual property right relating to any combination, machine, or process in which TI products or services are used. Information published by TI regarding third-party products or services does not constitute a license from TI to use such products or services or a warranty or endorsement thereof. Use of such information may require a license from a third party under the patents or other intellectual property of the third party, or a license from TI under the patents or other intellectual property of TI.

Reproduction of TI information in TI data books or data sheets is permissible only if reproduction is without alteration and is accompanied by all associated warranties, conditions, limitations, and notices. Reproduction of this information with alteration is an unfair and deceptive business practice. TI is not responsible or liable for such altered documentation. Information of third parties may be subject to additional restrictions.

Resale of TI products or services with statements different from or beyond the parameters stated by TI for that product or service voids all express and any implied warranties for the associated TI product or service and is an unfair and deceptive business practice. TI is not responsible or liable for any such statements.

TI products are not authorized for use in safety-critical applications (such as life support) where a failure of the TI product would reasonably be expected to cause severe personal injury or death, unless officers of the parties have executed an agreement specifically governing such use. Buyers represent that they have all necessary expertise in the safety and regulatory ramifications of their applications, and acknowledge and agree that they are solely responsible for all legal, regulatory and safety-related requirements concerning their products and any use of TI products in such safety-critical applications, notwithstanding any applications-related information or support that may be provided by TI. Further, Buyers must fully indemnify TI and its representatives against any damages arising out of the use of TI products in such safety-critical applications.

TI products are neither designed nor intended for use in military/aerospace applications or environments unless the TI products are specifically designated by TI as military-grade or "enhanced plastic." Only products designated by TI as military-grade meet military specifications. Buyers acknowledge and agree that any such use of TI products which TI has not designated as military-grade is solely at the Buyer's risk, and that they are solely responsible for compliance with all legal and regulatory requirements in connection with such use.

TI products are neither designed nor intended for use in automotive applications or environments unless the specific TI products are designated by TI as compliant with ISO/TS 16949 requirements. Buyers acknowledge and agree that, if they use any non-designated products in automotive applications, TI will not be responsible for any failure to meet such requirements.

Following are URLs where you can obtain information on other Texas Instruments products and application solutions:

### Products

Amplifiers	<a href="http://amplifier.ti.com">amplifier.ti.com</a>
Data Converters	<a href="http://dataconverter.ti.com">dataconverter.ti.com</a>
DSP	<a href="http://dsp.ti.com">dsp.ti.com</a>
Clocks and Timers	<a href="http://www.ti.com/clocks">www.ti.com/clocks</a>
Interface	<a href="http://interface.ti.com">interface.ti.com</a>
Logic	<a href="http://logic.ti.com">logic.ti.com</a>
Power Mgmt	<a href="http://power.ti.com">power.ti.com</a>
Microcontrollers	<a href="http://microcontroller.ti.com">microcontroller.ti.com</a>
RFID	<a href="http://www.ti-rfid.com">www.ti-rfid.com</a>
RF/IF and ZigBee® Solutions	<a href="http://www.ti.com/lprf">www.ti.com/lprf</a>

### Applications

Audio	<a href="http://www.ti.com/audio">www.ti.com/audio</a>
Automotive	<a href="http://www.ti.com/automotive">www.ti.com/automotive</a>
Broadband	<a href="http://www.ti.com/broadband">www.ti.com/broadband</a>
Digital Control	<a href="http://www.ti.com/digitalcontrol">www.ti.com/digitalcontrol</a>
Medical	<a href="http://www.ti.com/medical">www.ti.com/medical</a>
Military	<a href="http://www.ti.com/military">www.ti.com/military</a>
Optical Networking	<a href="http://www.ti.com/opticalnetwork">www.ti.com/opticalnetwork</a>
Security	<a href="http://www.ti.com/security">www.ti.com/security</a>
Telephony	<a href="http://www.ti.com/telephony">www.ti.com/telephony</a>
Video & Imaging	<a href="http://www.ti.com/video">www.ti.com/video</a>
Wireless	<a href="http://www.ti.com/wireless">www.ti.com/wireless</a>

Mailing Address: Texas Instruments, Post Office Box 655303, Dallas, Texas 75265  
Copyright © 2008, Texas Instruments Incorporated